

LABBEASY

LABBEASY

Paper Chains - Summer

12 different summer-themed paper chain templates

LABBEASY



LABBEASY



LABBEASY

PDF 4082-EN

LABBEASY

LABBEASY

Paper Chains - Summer

Overview	Page 3
Instructions	Page 4
Paper chain templates	Pages 5 - 16

LABBEASY

PRINT SETTINGS

Please use Acrobat Reader to print and make sure that the settings 'Actual size' and 'Auto portrait/landscape' are selected.

LABBEASY

SAVE PAPER & TONER

Only print out the pages you need.

COPYRIGHT & LICENCE

This material is protected by copyright. Labbé holds exclusive rights. © Labbé Publishing

This PDF file may only be used by the original purchaser and is intended for personal use and teaching. Distribution of the PDF file to school staff or to parents and students is not permitted. It is also not permitted to make it available on the internet or to place it on a school server. It is prohibited to use the PDF file, printouts of the PDF file, and objects created from it for commercial purposes. For more information, visit www.labbeasy.com

LABBEASY

OVERVIEW

Paper Chains - Summer



WATER POLO

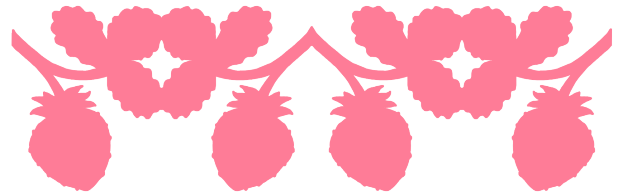

STRAWBERRIES



DRAGONFLY



ROLLERBLADER



STARFISH



SAILBOAT



BUCKET



ICE CREAM CONE

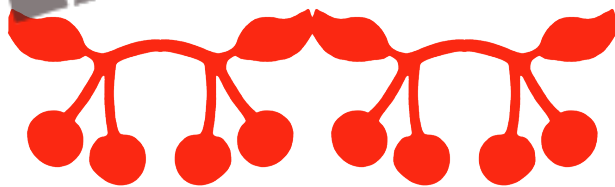

CHERRIES



DOLPHIN

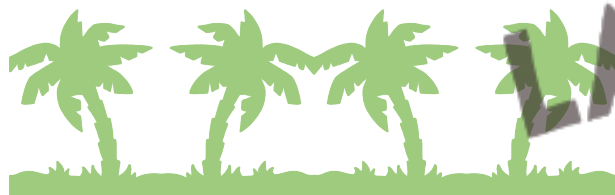

PALM TREE



DUCK FLOATIE

HOW TO MAKE IT

Paper Chains - Summer

1

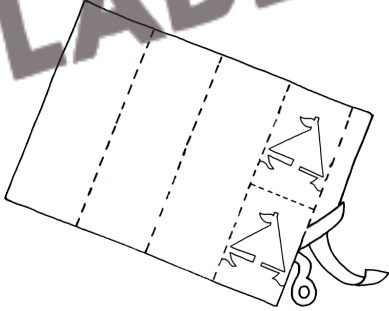

Print out your chosen paper chain template and cut out the frame along the solid line.

2

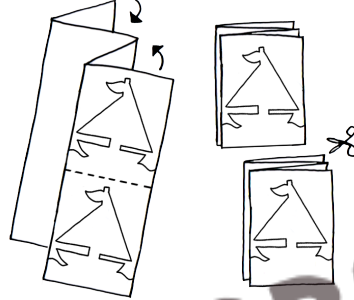

Fold the paper once down the middle along the dotted line. Then fold both sides again along the dotted lines, creating an accordion fold and so that you can see the shape on top.

3

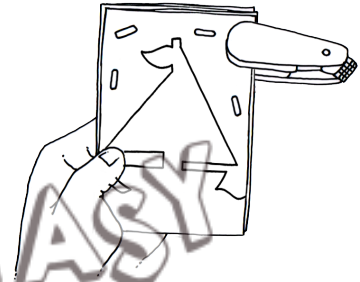

Use a stapler to staple the layers together so they don't move as you cut out the shape. Be careful not to staple too close to the shape.

4



Now you can cut out the shape along the gray line. Try to cut along the line as accurately as possible and be sure not to cut through the fold on the edge of the page.

5

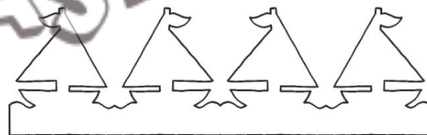

Once the shape is cut out, carefully unfold it. You can then glue several of these together to form a long paper chain.



LABBEASY

LABBEASY

LABBEASY

